



intelligent boxes

my
RENZ
box

Smart Click & Collect units
to optimise your sales processes



RETAIL

myRENZbox – Smart solutions for independent retailers

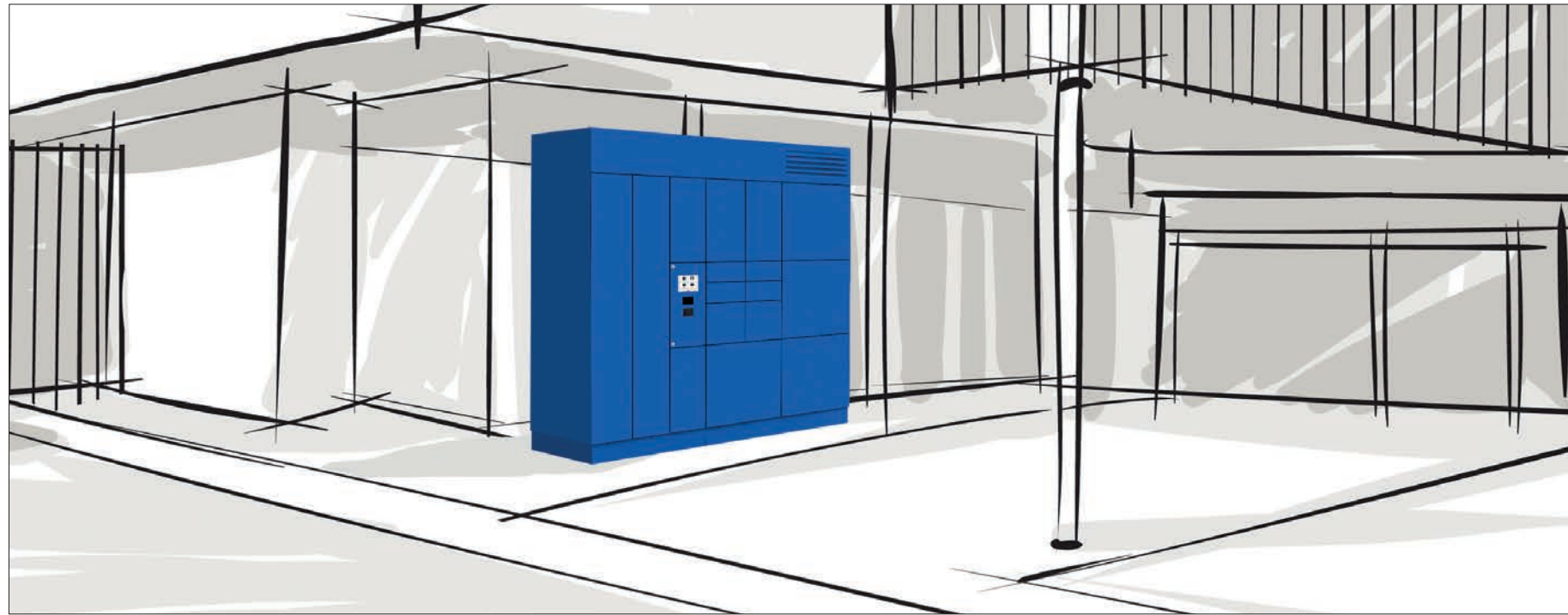

- 6 myRENZbox – Click & Collect solutions
- 12 myRENZbox – Transfer units
- 14 myRENZbox – Mobile units
- 16 Intelligently connected and managed

- 24 Modular design
- 26 Individual design
- 28 Pallet boxes
- 30 Chilled boxes
- 32 Equipment options
- 36 Service and maintenance
- 38 Renz

Online ordering is growing rapidly. Intelligently connecting online and offline retail is therefore becoming increasingly important. With a myRENZbox unit, your customers can generally collect a product ordered from you on the same day – around the clock, seven days a week.

And as your online shop can be connected directly to the myRENZbox unit, thanks to modern information technology, so-called Click & Collect or transfer solutions can be significantly improved. Your customer orders online, your employees then simply place the goods in the correct box, and the customer is notified electronically.

Whether electronics products or chilled food – your customers can then collect their orders at any time and, at the same time, use a customer card to pay at the terminal on the unit. If required, a barcode scanner can also assist with authorisation. The electronic lock opens the corresponding box and releases the product ordered to the customer. And returns are also very simple and can be done around the clock with the myRENZbox unit.

The myRENZbox unit is also an ideal tool when a product is to be handed over without personal contact – for example to prevent the transmission of pathogens.

And, of course, you can conveniently control your unit – and even several units simultaneously – using the myRENZbox portal, enabling you to stay up to date with the input and output of goods.

Our new brochure showcases the many different uses of the innovative myRENZbox units in retail. We hope that you enjoy browsing through the brochure and are certain of one thing: you're sure to find the right solution for your company.

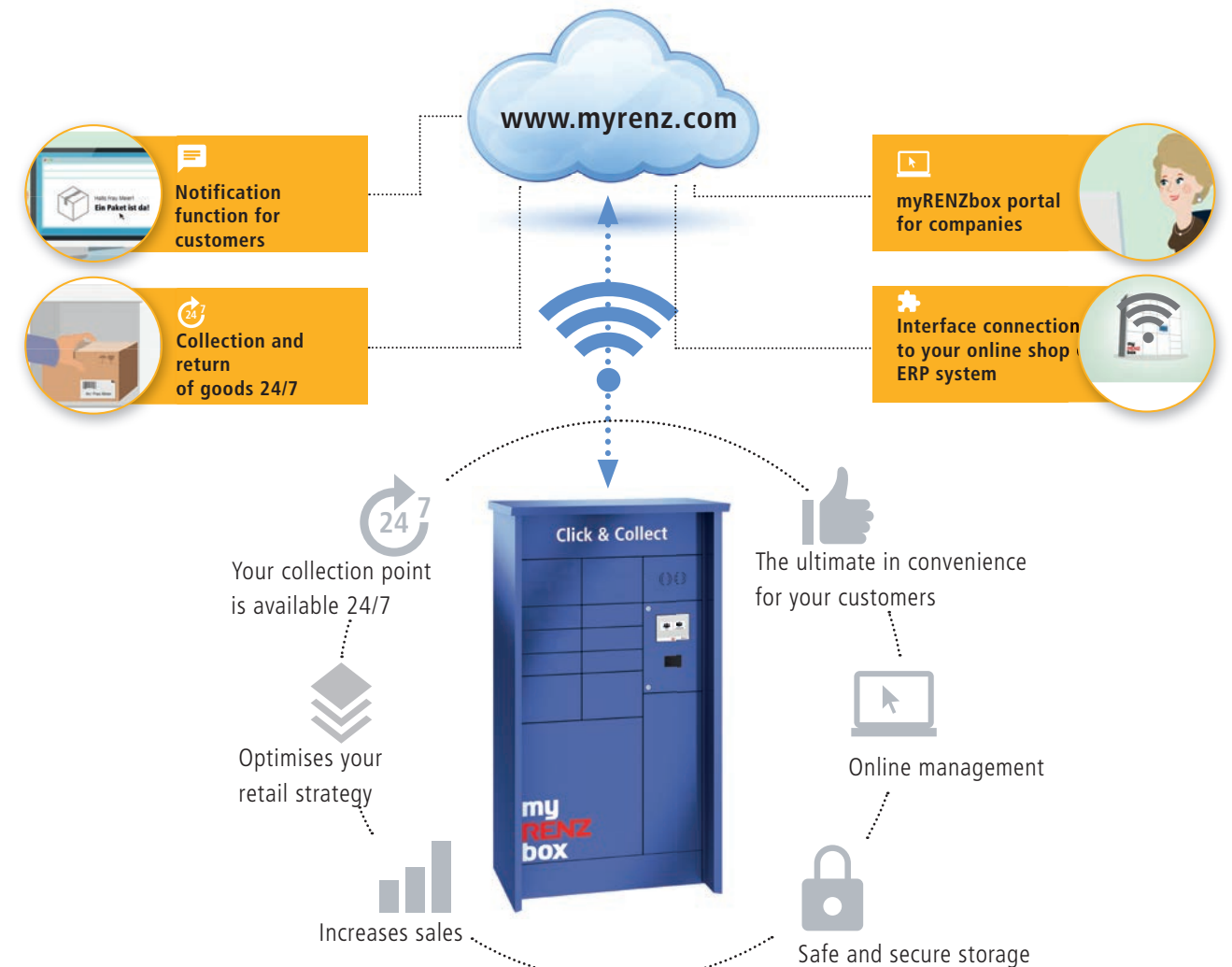

Point of Sales solutions

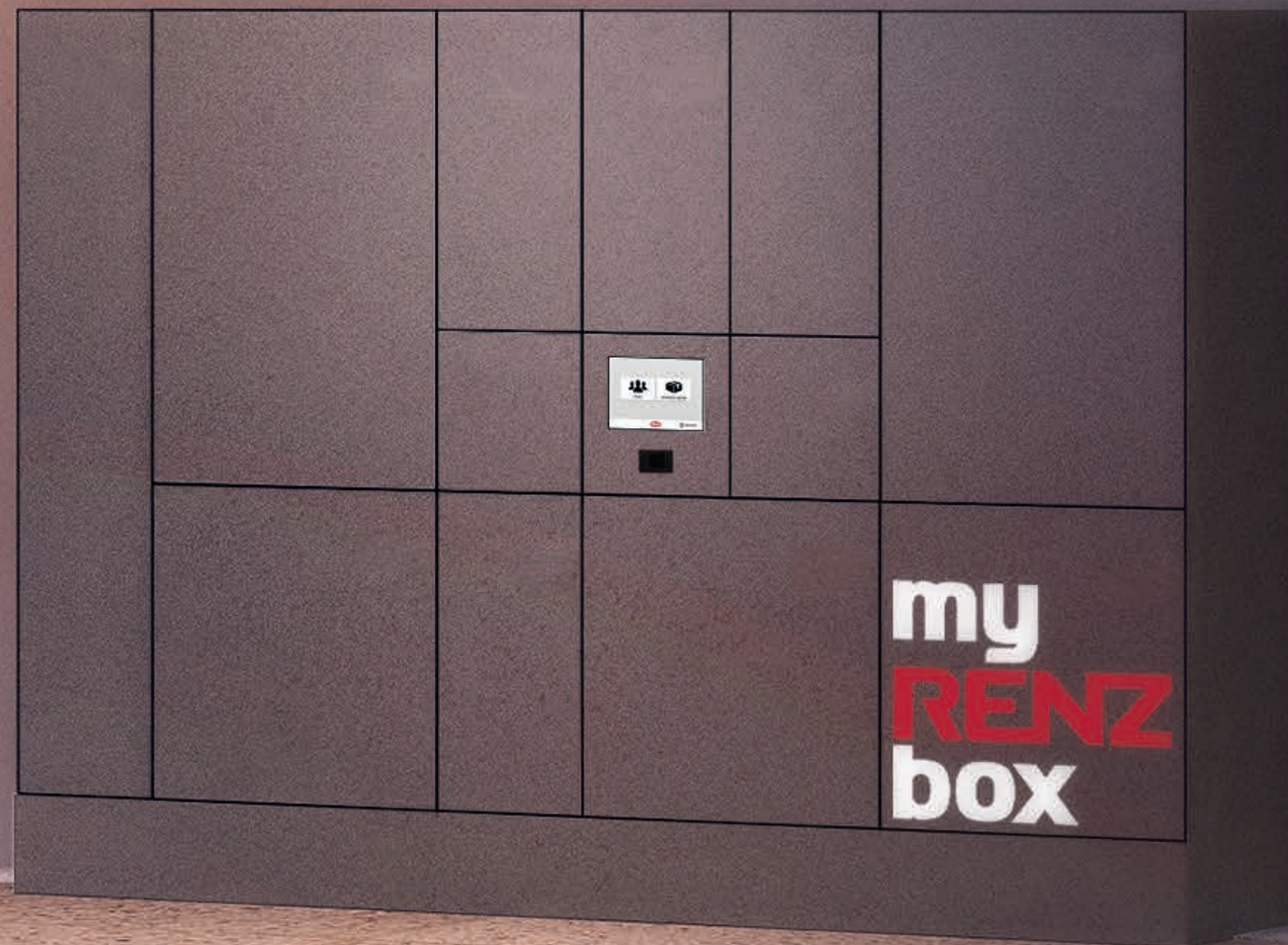

Click & Collect

Transfer units

Click & Collect
Ice & Fresh

Mobile units

Click & Collect
City Mall

Click & Collect



Order online, collect locally

Ordering goods online is transparent and convenient. Online retail is therefore growing constantly. On the other hand, many customers really value the personal contact they have with their local retailers – ultimately they receive good advice and it builds a growing relationship of trust – often the initial basis for a purchase. A **myRENZbox** Click & Collect unit offers you the option of combining the best of both worlds: your customers order online and collect their goods on site – around the clock, without waiting times and without additional shipping costs. And they can also conveniently return goods to the unit. As a retailer, this lets you generate additional sales,

at the same time as taking the pressure off your checkout zone. And when the store occasionally was just ticking over, employees can now use these times to fill up the unit.

Naturally your **myRENZbox** unit is precisely tailored to the needs of your company. You can manage it conveniently online – if required you can even link your ERP interface (online store, goods management system) to the **myRENZbox** portal. And should you need more space over time: you can also extend the unit at a later date, offering you even greater reliability for the future.

E-commerce is booming. Successful companies are therefore increasingly relying on multi-channel solutions, which combine electronic and high-street buying channels with each other. Our intelligent **myRENZbox** units offer you the option of further improving the link between online and offline retail. With today's buzz word "Click & Collect", your customers can order products online and collect the goods directly in situ – generally even on the same day. Your customers will benefit from your **myRENZbox** unit – and you'll increase your sales opportunities.

Sectors and users

Independent retail stores, builder's merchants, DIY stores, fashion, beauty/health, childcare, homeware, toys, gardening stores and more.

Benefits for companies/retailers:

- ✓ Linking of online and offline retail
- ✓ Innovative service offering 24/7
- ✓ Extended opening hours, greater customer loyalty
- ✓ Contactless transfer
- ✓ Simple online management on the myRENZbox portal
- ✓ Unit can also be configured to meet your individual needs
- ✓ Connection to your ERP interface is possible

Benefits for customers:

- ✓ Goods can be collected and returned independently of your opening hours
- ✓ No delivery time or waiting time
- ✓ Saving of shipping costs
- ✓ Notification of availability of goods
- ✓ Intuitive operation
- ✓ Simple collection is possible with a customer card
- ✓ Contactless transfer

myRENZbox Click & Collect

Location: Karlsruhe (Germany)

Purpose:

Independent retail

Features of the unit:

10 parcel boxes, individual design, free-standing, 32" control unit, individual powder coating in RAL 9007



Click & Collect Ice & Fresh



More and more orders are being placed online with independent food retailers as well. Regardless of whether you run a supermarket, butcher or cheese dairy: the refrigeration chain for many foods needs to remain intact. **myRENZbox** Click & Collect units can therefore also be equipped with chilled boxes. Three different temperature zones provide you with the flexibility you need: even frozen products can be stored with ease and your customers can collect them at any time – 24 hours a day, seven days a week.

Keeping the refrigeration chain intact

There is also an option to equip the **myRENZbox** unit with chilled boxes to enable customers of food stores or supermarkets to fully enjoy the benefits of Click & Collect solutions. Chilled foods can therefore be ordered online just as conveniently and collected locally as non-temperature-sensitive products – the refrigeration chain remains intact.

Three different zones from -18 to $+16$ degrees Celsius provide the right temperature for every product. For added safety, all compartments are equipped with thermal sensors, which monitor the refrigeration chain to ensure that it is not interrupted. These chilled compartments provide an ideal addition to the non-temperature controlled

Click & Collect system, particularly in independent food retail. Both types of boxes can be combined to form an extremely versatile unit. It is managed online using the **myRENZbox** portal – if required with the integration of your ERP interface (online store, goods management system) into the system. The **myRENZbox** unit with chilled boxes can be extended at any time to meet your needs.

Sectors and users

Supermarkets, independent food retailers, butchers, dairies, health food stores, fishmongers, cheese shops, ice cream shops, freezer centres, wine cellars, as well as pharmacies, test laboratories and more.

Benefits for companies/retailers:

- ✓ Innovative service offering 24/7
- ✓ Click & Collect service even for chilled foods
- ✓ Refrigeration chain is kept intact
- ✓ Chilled and non-chilled boxes can be combined with each other
- ✓ Contactless transfer
- ✓ Online management via the myRENZbox portal
- ✓ Unit can also be configured to meet your individual needs
- ✓ Connection to your ERP interface is possible

Benefits for customers:

- ✓ Chilled products can be collected independently of store opening times
- ✓ No waiting at the checkout
- ✓ Notification of availability of goods
- ✓ Intuitive operation
- ✓ Simple collection is possible with a customer card
- ✓ Contactless transfer

myRENZbox Click & Collect Ice & Fresh

Location: Amiens (France)

Purpose:

Independent retailer/supermarket

Features of the unit:

6 chilled compartments at $+4$ °C,
6 chilled compartments at -18 °C,
11 non-chilled compartments



Click & Collect City Mall



Whether you operate in a shopping mall, local urban district or pedestrian zone: a **myRENZbox** Click & Collect unit can be shared with ease by several stores. This saves investment costs, offering you as a retailer all the benefits of a multi-channel solution – even if your business does not have an online store, as goods ordered by phone can also be securely and discreetly placed in the **myRENZbox** unit. Your customers can conveniently collect goods they have ordered from several stores in the area in one place – around the clock and with no waiting times.

Maximising synergies

Stores in shopping malls or smaller independent retailers in urban districts can often benefit in particular from the use of a shared **myRENZbox** unit. There are greater advertising and synergy effects at the same time as sharing the investment costs with others: customers of the stores involved will be made aware of the product range offered by other Click & Collect partners. After all, thanks to the **myRENZbox** unit, goods ordered from several stores can be collected from a single place. Your customers can therefore make several purchases from home and collect them together – at a time of their choice and totally without long queues at the checkout. This benefits you as a retailer as it significantly extends your opening hours – without the added cost of extra employees. You will also stand out from the competition, even if you do not operate your own online store. Orders

placed by phone can also be conveniently handled using the **myRENZbox** unit. The integration of a locally usable app is also possible on request. It can be used by smaller independent retailers, like butchers or opticians, to offer their services, even if they do not have their own online store. Customers order using the app instead of online and the goods are placed just as simply into the box. The Click & Collect service also offers municipalities the opportunity of breathing new life into deserted city centres. Thanks to the 24/7 offering, potential customers are also attracted into the town centre who have relied fully to date on mail order retail.

Sectors and users

Shopping malls, shopping centres, businesses in a district or on a street, municipalities, car parks, airports and more.

Benefits for companies:

- ✓ Linking of online and offline retail
- ✓ Innovative service offering 24/7
- ✓ Shared use lets you benefit from synergies
- ✓ Increased appeal of inner-city stores
- ✓ Also ideal even if you have no online store
- ✓ Extended opening hours, greater customer loyalty
- ✓ Contactless transfer
- ✓ Connection to ERP interfaces and apps is possible
- ✓ Products can be collected independently of store opening times
- ✓ Combined collection of purchases from several stores
- ✓ No delivery time or waiting time
- ✓ Saving of shipping costs
- ✓ Intuitive operation
- ✓ Notification of availability of goods



Transfer units



A **myRENZbox** is also the perfect choice when it comes to the transfer of goods in connection with a service – for instance, hired sports equipment, an altered item of clothing or the key for a replacement loan car. The 24/7 service lets your customers collect or return products other than purchased goods around the clock – totally independently of your opening hours. The stored goods are also well protected from unauthorised access.

Make your products available

Whether you're running a sports shop or a car dealership with workshop – you know the scenario: your customers turn up outside of your opening hours to return rented sports equipment or collect a key for a replacement loan car. You therefore need a reliable solution to hand it over – possibly with accompanying paperwork.

A **myRENZbox** unit is the perfect tool in these situations. It lets you have extended opening hours as a round-the-clock service to your customers without any increased personnel costs. The customer conveniently authorises himself by code or customer card

and the corresponding box opens up for collection or return at any time of the day or night.

At the same time, the intelligent **myRENZbox** unit naturally also serves as a regular Click & Collect solution, possibly for the provision of goods purchased online. After all, regardless of whether you are involved with the handover of rented or sold products: flexible access times are an additional reason for many customers to be attracted to your product range. A veritable win-win situation.

Sectors and users

Alteration tailors, car dealerships offering a repair service, tool and machine hire, sports equipment hire, scooter hire and more.

Benefits for companies:

- ✓ Ideal solution for sales and hire
- ✓ Innovative service offering 24/7
- ✓ Extended opening hours, greater customer loyalty
- ✓ Contactless transfer
- ✓ Simple online management on the myRENZbox portal
- ✓ Unit can also be configured to meet your individual needs
- ✓ Connection to your ERP interface is possible

Benefits for customers:

- ✓ Fast and simple hire and return of items
- ✓ Flexible arrival times
- ✓ Notification of the availability of keys or goods
- ✓ Intuitive operation
- ✓ Simple collection is possible with a customer card
- ✓ Contactless transfer

myRENZbox transfer unit

Location: Billund Airport (Denmark)

Purpose:

Duty free shop

Features of the unit:

2 x 74 parcel boxes, RAL 7012S with film decals



Mobile units



Dimensions to suit

A mobile **myRENZbox** unit makes you fully flexible in terms of time and space. It can simply be set up at your required site by crane or fork-lift. Its special design means that no foundation is required, making the choice of the installation site very straightforward.

The 75-centimetre deep compartments consist of different modular versions you can combine as required. And if you have especially large products, you can even make use of box sizes of up to two metres in height. In spite of this, the external dimensions of the **myRENZbox** unit are compact, as the individual compartments are assigned dynamically and are therefore used to full capacity.

Whether you are running a DIY store or a supermarket, a **myRENZbox** unit means that you're perfectly equipped for your next trade fairs, sales events or company events. It's open to all stakeholders as a flexible Click & Collect and transfer solution – suppliers, logistics companies, customers and employees.

Using the system couldn't be simpler. And you can also check in the Event Log History if you would like to know afterwards whether an item has been delivered or removed. That's where all the deliveries and collections are saved.

myRENZbox solutions (with the exception of chiller units) can also be used outside of your company's premises – whether at trade fairs or sales events. Goods and other products can therefore be received and collected wherever you are working – around the clock, discreetly and securely. And when you relocate, the mobile **myRENZbox** unit simply moves with you. The platform can also be used as a smart locker unit to store goods you have bought.

Benefits for you as a businessperson:

- ✓ Simple to install by crane or fork-lift
- ✓ Capable of being used as standard up to wind load zone 3, with tougher requirements being available if required
- ✓ Large capacity, with a compartment depth of 75 cm
- ✓ Extra-large compartments up to 2 m high
- ✓ Unit can be configured to meet your needs (tailored to your company)
- ✓ Connection to your ERP interface (online store, goods management system) is possible
- ✓ myRENZbox 8" control unit
- ✓ NFC reader and LTE module as standard
- ✓ Multi-user function
- ✓ Operation using the myRENZbox app

myRENZbox mobile solutions

Location: Heilbronn (Germany)
Client: National Garden Show 2019

Purpose:
Event

Features of the unit:
39 parcel boxes, modular extended design, free-standing, **myRENZbox** control unit, individual powder coating in a RAL special colour



Intelligently connected



Anmeldung Logistiker



9

myRENZbox control unit

Remote control

myRENZbox control unit



The **myRENZbox** control unit is the central menu-driven operating unit for your system. There are two display sizes to choose from. Compared to the 8" version, the 32" touchscreen provides the option of simultaneously using the display for advertising or information. Navigation in both cases is user-friendly using an intuitively operated touchscreen. Your customers authenticate themselves either by the **myRENZbox** app, PIN, customer card, chip or barcode. And a terminal with a host of equipment options enables customers to pay conveniently there and then.

Control units

- ✓ Control units either with 8" or 32" touchscreen
- ✓ Individual screen design is possible
- ✓ Access permissions can be selected (whether RFID, PIN, Bluetooth, NFC, LEGIC, myRENZbox app etc.)
- ✓ Optional integration of existing access media (e.g. cards, chip, PIN, electronic key, transponder etc.)
- ✓ Payment terminal for EC and credit cards with receipt printer (optional)
- ✓ NFC reader for contactless payment (optional)
- ✓ Notification function by e-mail, SMS text or push message on collection or return of goods.
- ✓ Dynamic allocation of compartments (different compartment sizes per recipient)
- ✓ Personalised settings using the myRENZbox portal

Connected interface

Your **myRENZbox** unit is fully connected as the interface between online and offline retail. As soon as goods ordered online have been deposited by you in one of the compartments, the customer receives notification by e-mail, SMS text or push notification in the **myRENZbox** app that the goods are awaiting collection. Following authentication and payment at the terminal, the door to the compartment opens automatically.

display. With 16 times the surface area, you can also use it as an information terminal. The screen content changes at a defined time interval. When touched, the user interface appears for operation of the unit. You can also individualise the screen in line with your Corporate Design.

8" and 32" control units

There is also a 32" version available in addition to the 8" control unit with touch

Payment terminal

The **myRENZbox** control unit can be equipped with a payment terminal. Customers can pay by EC or credit card as well as contactlessly using an NFC reader. A receipt printer can print receipts if required.

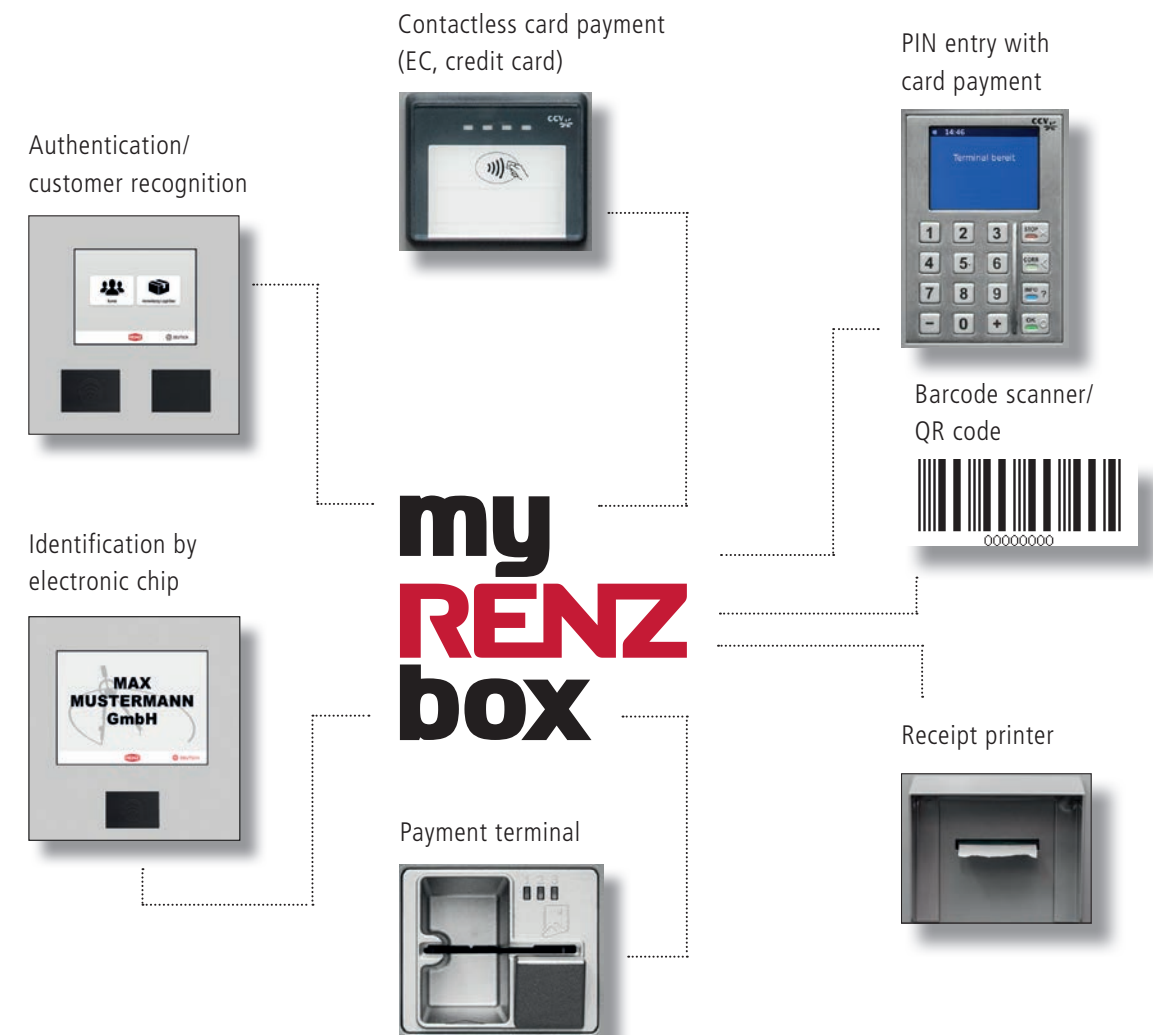

Remote control using the **myRENZbox** portal



The **myRENZbox** portal can be used to manage numerous units centrally. Apart from issuing and withdrawing access authorisations, logistics processes can be enabled and disabled and current information accessed on the use and status of the units. It is also possible to integrate interfaces to existing online store solutions, ERP systems or databases.

Central online management

The **myRENZbox** portal lets you manage one or more units centrally online – totally conveniently from your desk. You can also access all the latest information on the use and status of the units, and all transactions are logged. If some of your customers do not use a smartphone with the **myRENZbox** app, you can also assign PIN numbers for the collection and return of goods. And you can also check in the Event Log History if you would like to know afterwards whether something has been removed or returned. All the movements are stored in the history.

Online shop solutions, ERP units or databases already in place can optionally be integrated into the unit with interfaces.

IT interface integration

www.myrenz.com

Benefits:

- ✓ Simple remote management of single or multiple units
- ✓ Status and functional overview of all units
- ✓ Analysis of the level of use of the unit, compartments and the number of collections/returns and service messages
- ✓ Issue and withdrawal of access permissions for users
- ✓ Interface integration to online shop solutions, ERP systems or databases already in place (optional)

Individual screen design, connection to the online shop's database or goods management system. If standard solutions do not suit the customer, then we can also develop a solution in a joint workshop.

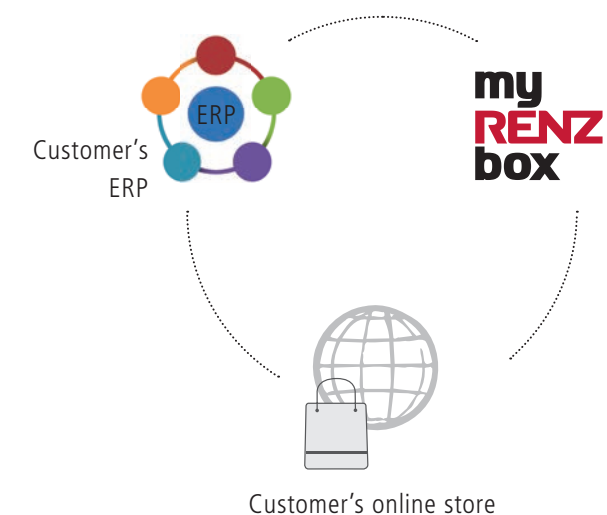

Configured to your requirements

mu
RENVZ
box

Modular design

Chilled boxes

Individual design

Equipment options

Pallet boxes

Modular design



System design

If you opt for a modular **myRENZbox** unit, you can combine and extend the basic module with various module versions – even retrospectively. The extended versions are available should you need especially large compartments.

The basic module with the **myRENZbox** 8" control unit can also be used outdoors (please state if required) and can optionally be equipped with a Wi-Fi or LTE module.

Looking for a cost-effective solution? Then the modular design of the **myRENZbox** unit is the right choice for you. The basic module of the **myRENZbox** control unit can be combined with many module versions, as required. And a total of up to 500 compartments are possible, thanks to the **myRENZbox** 8" control unit.

Standard

Basic module:

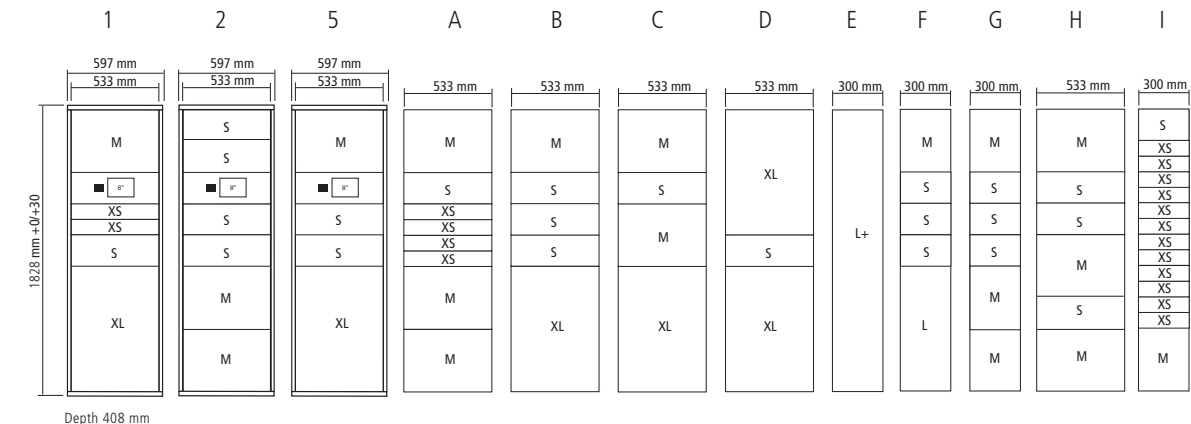

Extended

Basic module:

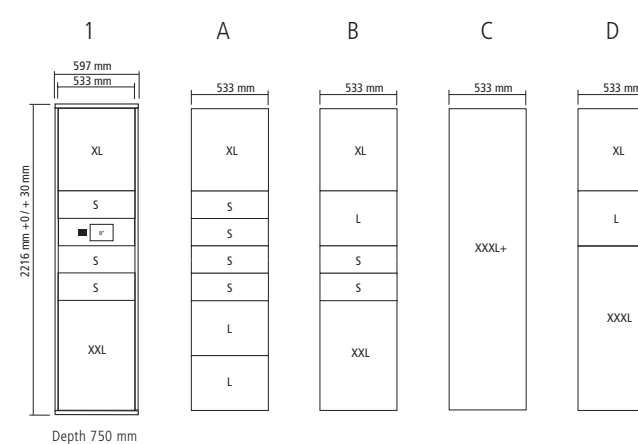

External dimensions in mm (w x h x d)

Box	Standard 300 mm wide	Standard 533 mm wide	Extended 533 mm wide
XS	300 x 97 x 408	533 x 97 x 408	–
S	300 x 194 x 408	533 x 194 x 408	533 x 194 x 750
M	300 x 388 x 408	533 x 388 x 408	–
L	300 x 776 x 408	–	533 x 388 x 750
L+	300 x 1746 x 408	–	–
XL	–	533 x 776 x 408	533 x 582 x 750
XXL	–	–	533 x 776 x 750
XXXL	–	–	533 x 1164 x 750
XXXL+	–	–	533 x 2134 x 750

Product features at a glance:

- ✓ Made of corrosion-resistant steel
- ✓ Over 200 RAL colours (matt)
- ✓ For indoor use
- ✓ For outdoor use
- ✓ Available as a free-standing unit
- ✓ Integrated 8" Renz control unit
- ✓ NFC reader fitted as standard
- ✓ Wi-Fi module/LTE module (optional)
- ✓ Electronically and mechanically extendible
- ✓ Payment terminal (optional)

Individual design



Freely configurable

The individual design of the **myRENZbox** unit is tailored precisely to your needs. It can be freely configured – both in terms of the casing design and the box sizes. V4A stainless steel is available in addition to countless colour options – even for the interior of the housing.

Chilled boxes with different temperature zones or ultra-large compartments – for instance to accommodate euro pallets – can also be integrated into an individually designed **myRENZbox** unit.

If you opt for an individual design, your **myRENZbox** unit will be tailored completely to your needs. Apart from the various box sizes, this means that you also have a wide range of configurations and casing designs. You can also choose from a **myRENZbox** control unit with an 8" display and the considerably larger alternative with a 32" display.

Combination options

M	XL	XL	XL
L	M	■	■
	XL	XL	XL
L	XL	XXL	XXL
	XL		

Benefits for you as a businessperson:

- ✓ Maximum flexibility
- ✓ Different casing designs
- ✓ Galvanised steel or V4A stainless steel housing interiors are possible
- ✓ Special sizes are possible
- ✓ Indoor and outdoor versions available
- ✓ Over 200 RAL colours or V4A stainless steel
- ✓ Integrated myRENZbox 8" or 32" control unit
- ✓ NFC reader fitted as standard
- ✓ Wi-Fi module/LTE module (optional)
- ✓ Electronically extendible
- ✓ Combinable with chilled and pallet boxes

Parcel box sizes with individual design

We offer the following standards with further options on request.

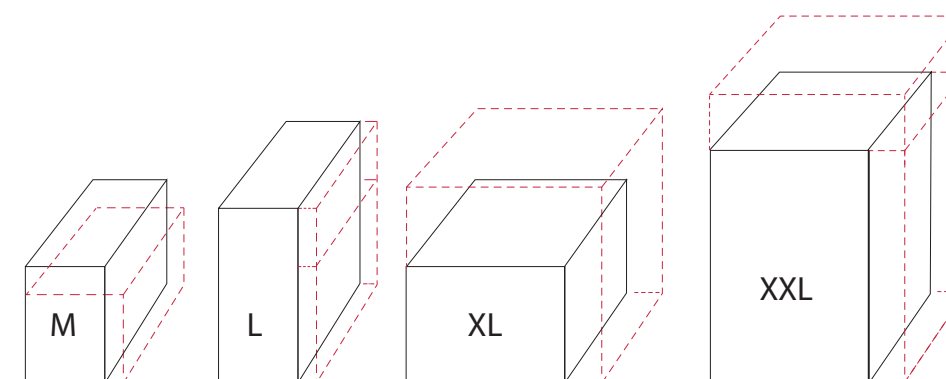

External dimensions in mm (w x h x d)

Box	300/600 mm wide	litres
M	300 x 440 x 450	59
L	300 x 660 x 450	89
XL	600 x 440 x 450	119
XXL	600 x 880 x 450	238
XXXL	–	–

Box	370/740 mm wide	litres
M	370 x 330 x 450	55
M	370 x 440 x 450	73
L	370 x 660 x 450	110
XL	740 x 440 x 450	147
XXL	740 x 880 x 450	293
XXXL	740 x 1100 x 450	366

Pallet boxes can be integrated into an individual design



The solution for bulky goods

An individually designed **myRENZbox** solution offers you the option of integrating large-volume boxes as well as standard size compartments into your unit. This is of particular benefit if your goods often exceed normal commercial sizes. The sizes even extend to euro pallet-format boxes with roller shutters. Non-standard sized boxes can be combined with standard sized boxes in an individually designed unit.

If you wish to deliver bulky or heavy goods, then the individually designed **myRENZbox** unit also offers you the option of integrating specially sized boxes. That way you can even deliver entire pallets for collection by your customers or business partners.

Large-volume boxes

The dimensions of the large-volume boxes with roller shutter are based on the dimensions of euro pallets.

Basic module optionally with payment terminal

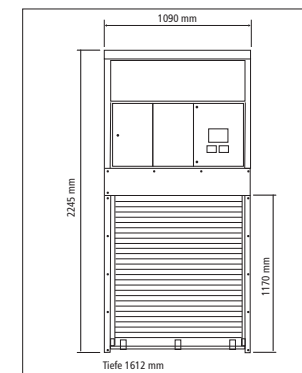

Extension module 1

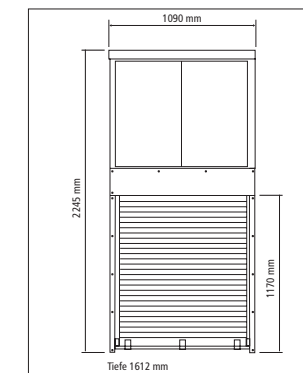

Extension module 2

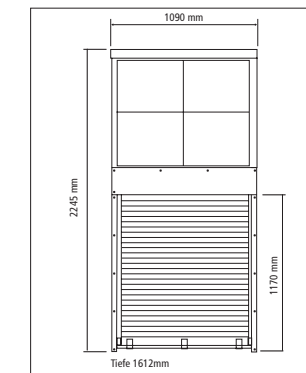

Extension module 3

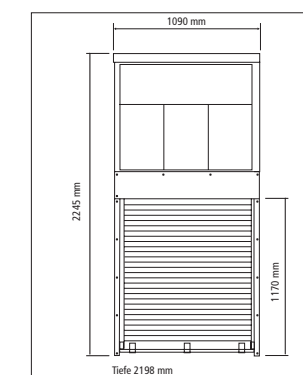

Extension module 4

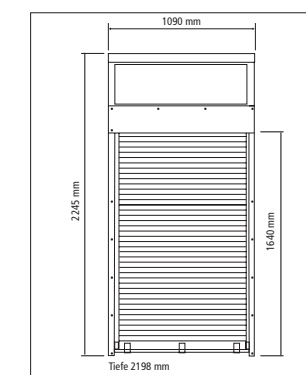

Benefits for you as a businessperson:

- ✓ Maximum flexibility
- ✓ Galvan housing interior
- ✓ For outdoor use
- ✓ Over 200 RAL colours
- ✓ Integrated myRENZbox 8" control unit
- ✓ NFC reader fitted as standard
- ✓ Wi-Fi module/LTE module (optional)
- ✓ Electronically extendible
- ✓ Combinable with chilled and parcel boxes

Chilled boxes can be integrated into an individual design



As a food retailer, it is important to you to be able to deliver chilled produce for collection as well. Chilled boxes with three different temperature zones from -18 to +16 degrees Celsius offer you maximum flexibility here. Whether you supply frozen food, meat or chocolate: every product will arrive at the customer at the correct temperature – and the refrigeration chain remains intact.

Product features at a glance:

- ✓ Fast temperature control
- ✓ Even temperature
- ✓ Automatic defrosting
- ✓ Temperature sensor in each box
- ✓ Alarm if the limit is exceeded
- ✓ Ventilated cooling
- ✓ Removable chilled unit
- ✓ Insulation using CFC-free polyurethane foam panels
- ✓ Seals can be removed without tools for simple after-sales service
- ✓ Doors with magnetic seals

Reliably chilled

The constant cooling of the boxes is possible, thanks to a system that uses air cooling to rapidly lower the temperature, guaranteeing even temperature distribution. A fan ensures even air circulation. All boxes are equipped with a thermal sensor, which monitors that the refrigeration chain is kept intact. Automatic defrosting by the circulation of hot gas prevents the formation of frost. The condensation formed by defrosting is evaporated. The formation of ice is prevented by the controllability of the system and the unit's performance remains at a constant level.

The chiller boxes of the **myRENZbox** unit are sealed by two coupled doors: once the customer has been authorised, the outer door of the relevant box is first opened automatically. However, only when the insulated door is manually opened does the customer have access to the chilled compartment. That way the goods remain protected until they are removed. The chiller unit is connected to the central control of the **myRENZbox** unit. The unit can be extended, as required, at any time and also combined with other types of boxes.

Ease of maintenance

Maintenance and after-sales care are very convenient as the chiller unit can be removed. Fast and straightforward reaction is possible in the event of changes to liquid regulations or technological innovations.

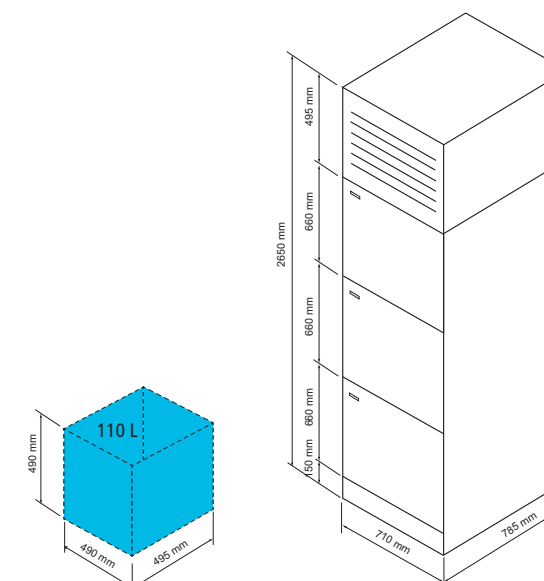

myRENZbox temperature zones

	ice box ❄️❄️❄️	fresh box ❄️❄️	temperate box ❄️
Temperature*	-18 °C	+4 °C	+16 °C
Control range*	-21 °C to -18 °C	+2 °C to +5 °C	+13 °C to +18 °C
Suitable for ...	Ice cream, frozen products	Meat, sausages, fish, dairy produce, fruit, vegetables	Wine, chocolate, flowers, cake

*The specified temperatures apply, with a variable speed condenser fan, up to an ambient temperature of +40 °C.

Equipment options



Use a sturdy canopy to protect your **myRENZbox** unit if it is to stand outdoors and be exposed to the wind and weather. Renz provides extremely sturdy canopies to protect your unit – individually tailored to your needs and those of your unit, in a range of casing designs and colours.

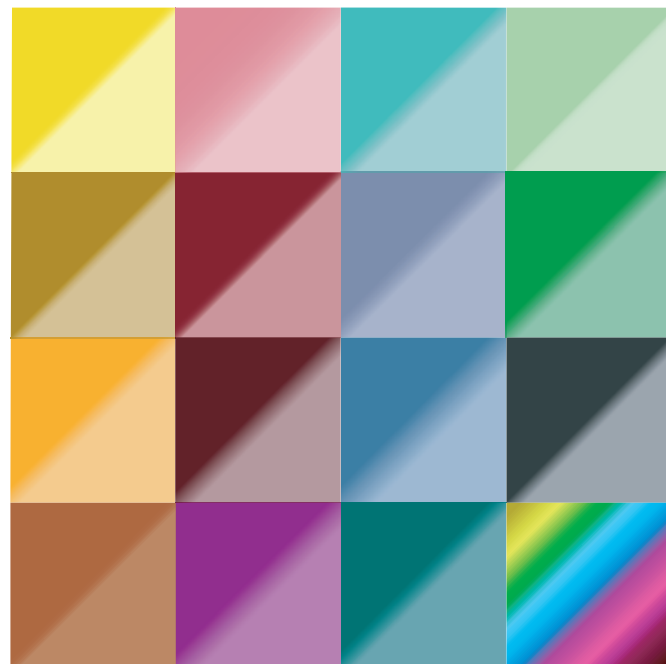

Select from over 200 colours

Make the most of the opportunity to individualise your **myRENZbox** unit. A range of powder coated finishes in over 200 different RAL colours is available to you. And even non-RAL colours are available on request. Individual unit designs can also be produced in brushed stainless steel or V4A – and if technically feasible from a powder paint aspect – in a colour provided by you.

Be individual

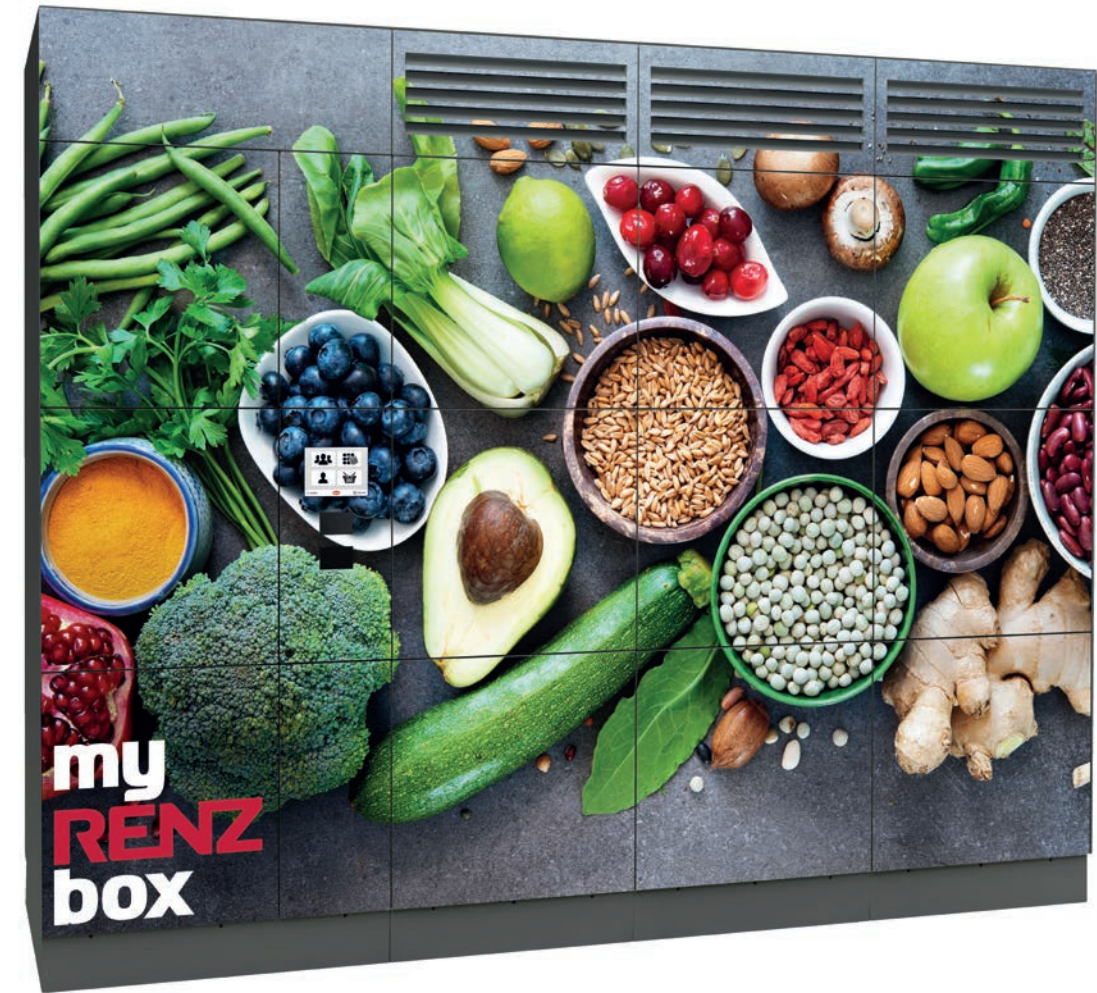

Showcase your **myRENZbox** units. Label them to your requirements – either with partial or full film decals. Whether logos, slogans or coloured logos: there are simply no limits to your ideas. We can even engrave the box – partly with LED backlighting. There are almost unlimited labelling options on all available materials.

We're your
partner

RENZ
SERVICE

Service

About Us

Our service

Installation, commissioning and training



We offer professional installation on site by trained fitters to guarantee the optimum operation of your units from the outset. Following commissioning, we will demonstrate the extensive functions of the parcel box units to you and train you in using the www.myrenz.com online portal.

Our maintenance contracts

We won't leave you in the lurch even after the sale, and recommend concluding service and maintenance contracts, which offer three different service levels from Renz Service GmbH. All three kinds of maintenance contracts build on each other in terms of services provided.

Our **Maintenance Software** is the entry level with regular updates, notification by e-mail and push notifications by app and basic functions in the operator portal.

Basic Maintenance adds on an annual service on site (including a service report) and advanced functions in the operator portal (e.g. statistics).

Our **Top Maintenance** also includes the free replacement of all components* should they fail.

All three maintenance contracts include parcel and goods insurance of up to €1000 for each claim and compartment. We'd be happy to advise you on the full scope when selecting the right maintenance contract to meet your needs.

*Not caused by vandalism or failure due to natural catastrophes

myRENZbox – Maintenance contracts at a glance

The minimum term of our maintenance contracts for the seamless operation of your **myRENZbox** (see page 36) is 24 months.

The contract is automatically extended by a further 12 months and can be terminated with 3 months' notice at the end of the contract.

Software/App	Maintenance Software	Basic Maintenance	Top Maintenance
Operator portal for administration and user portal for residents	●	●	●
Advanced functions in the operator portal (including statistics etc.)	–	●	●
Software updates and maintenance in the purchased modules	●	●	●
Notification function by email and push messages through the myRENZbox app	●	●	●
Additional notification function by SMS text	–	–	●
myRENZbox app for authorisation of users of the myRENZbox	●	●	●
Support			
Phone hotline from Monday to Friday 7.00 – 17.00	●	●	●
Service			
Annual maintenance including all labour and travel costs	–	●	●
Free quotations for services not covered by the service plan (chargeable repairs) and in the event of damage by vandalism	–	–	●
Free overhaul of the parcel box unit and replacement of faulty components (with the exception of vandalism)	–	–	●
Maintenance and thorough cleaning of the unit (inside and outside)	–	–	●
Documentation of services performed	–	●	●
Insurance			
Free parcel/goods insurance (for parcel delivery services/express delivery services, and company and service providers' factory deliveries) to myRENZbox parcel box units Insurance cover: Damage* caused by fire, theft, vandalism and storms Compensation per claim* and compartment* is limited to €1,000.	●	●	●
*Parcels and shipments with industrial use			
Optional services			
Data import of user data (initial handover)	○	○	○
Management and administration of your myRENZbox unit (user management, access authorisations)	○	○	○
Data exchange automated between your company software and your myRENZbox unit by API interface	○	○	○

● included ○ optional at a surcharge, – not possible

About Us

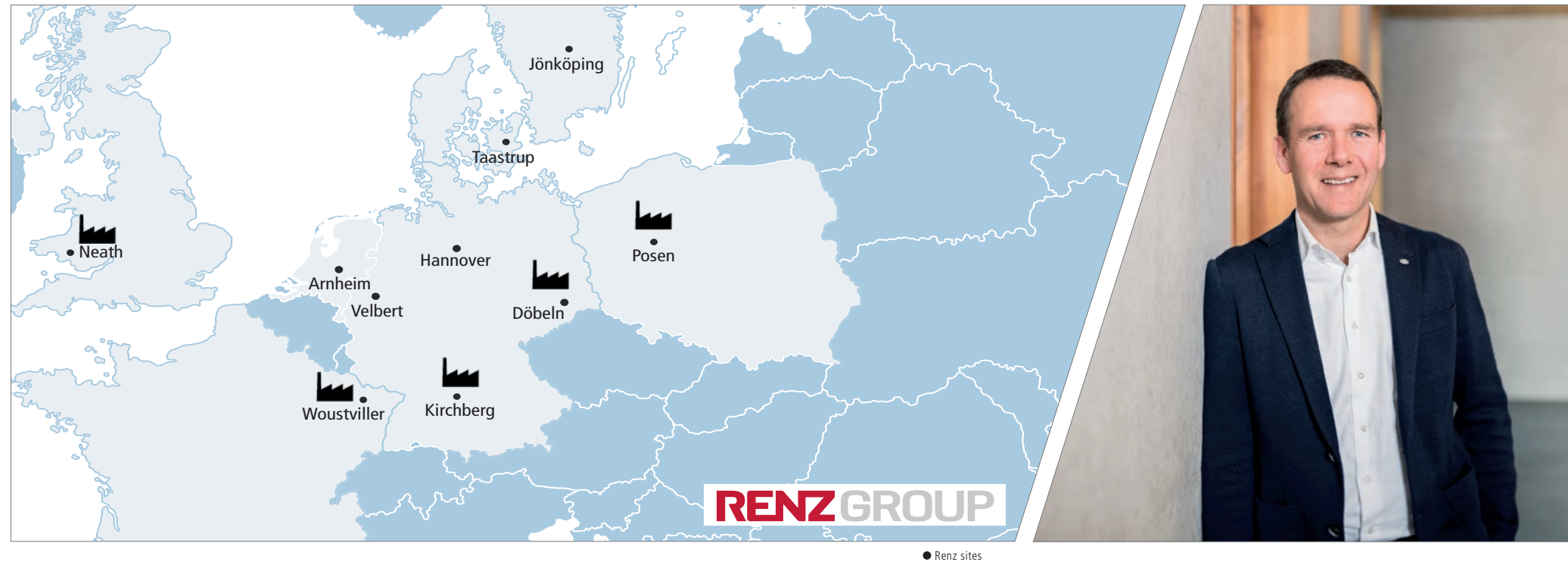

As an owner-managed company headquartered in the Baden-Wuerttemberg region of southern Germany, Renz now operates out of nine sites throughout Europe. Products for the European market are produced in Germany, France, Poland and Great Britain. Digitalisation trends were identified at an early stage and led to a large number of innovative patents. As the European market leader for mail and parcel box units, the extremely successful **myRENZbox** units were initially developed for real estate management before the company recently entered the retail and business market segment.

Dear Customers,

Top quality standards and constant innovations: this aim has made us the number one in the European mail and parcel box sector since 1925. As an owner-managed company, now in its third generation, we now operate with 800 members of staff at nine sites throughout Europe.

Our **myRENZbox** units are also completely manufactured in our factories in Germany, France, Poland and Great Britain. The Renz Group also has subsidiaries in Denmark and Sweden. We are therefore very familiar with the specific requirements of the different European countries.

However, one factor applies to all regions: digitalisation is fundamentally changing retail. E-commerce is booming and increasingly dovetailing with high-street retail. Our vision: the global urban project. All local businesses and customers will benefit from the Click & Collect principle by equipping shopping streets, shopping malls and entire districts with **myRENZbox** units.

We are creating a mutually compatible and interoperable infrastructure consisting of versatile usable transfer solutions together with internationally leading providers from the digitalisation and logistics sectors. This will also save you investment costs as an independent retailer and increase synergies as well as sales opportunities. This will breathe new life into city centres, and sustainable logistics concepts will reduce urban traffic and CO₂ emissions.

We hope that you are just as inspired by our versatile usable and individually configurable **myRENZbox** units as we are – we're convinced that we have an optimum solution for your company or shopping district as well.

Warmest regards,

Armin Renz

Into the future with innovations



1925 Establishment of the company by Erwin Renz.



1965 Martin and Manfred Renz focus the business on mailboxes.



2004 Armin Renz takes over the management of the family-owned company – now in its third generation.



2007 The first mechanical parcel box unit is launched.



intelligent boxes

2015 Renz embarks on sales of the **myRENZbox**, the intelligent transfer solution for retail, residential and business.

As the European market leader, we also have solutions for apartment blocks and companies:



myRENZbox solutions for apartment blocks



myRENZbox solutions to optimise your internal business processes

March 2020 version

We reserve the right to make technical changes.
Figures sometimes show non-standard equipment.
Colour deviations are possible

Renz Service GmbH

A Renz Group company

Phone +49 (0) 71 44 / 8 86 75 50

E-mail service@renzgroup.de

Erwin Renz Metallwarenfabrik GmbH & Co KG

Boschstrasse 3 · 71737 Kirchberg/Murr · Germany

Phone +49 (0) 71 44 / 301-0

Fax +49 (0) 71 44 / 301-44 44

E-mail info@renzgroup.de

www.renzgroup.com

